



# Jim Sherman Memorial Northwest Championships 2014

## Portland, Oregon

### June 28 - 29, 2014

Rev. 06/21/2014

### Men's 40+ Masters Major Division • 5 Teams

Win	Loss		
1	1	1	Allstate Mayhem (WA)
2	0	2	Hara's Dynasty (WA)
0	2	3	Mach One 40's (WA)

Win	Loss		
0	2	4	Prey for Reign (WA)
2	0	5	Team Combat 40's (WA)

### Saturday • June 28, 2014 • William V. Owens Softball Complex at Delta Park

Time	#	Runs	Team Name	Field	#	Runs	Team Name
8:00 AM	4	16	Prey for Reign (WA)	B	2	24	Hara's Dynasty (WA)
8:00 AM	3	14	Mach One 40's (WA)	M	1	19	Allstate Mayhem (WA)
9:30 AM	2	34	Hara's Dynasty (WA)	B	3	6	Mach One 40's (WA)
9:30 AM	1	9	Allstate Mayhem (WA)	M	5	23	Team Combat 40's (WA)
11:00 AM	5	21	Team Combat 40's (WA)	M	4	11	Prey for Reign (WA)

Seeding for 40-Major Three-Game-Guarantee bracket commencing Saturday afternoon • See bracket

**FIELD CODES: B=Budweiser • DS=Dick's Sports • DM=DeMarini • J=Jubitz • M=Marathon • S=Snapple**

**Format:** Two (2) game Round Robin to seed 40-Major Three-Game-Guarantee Championship bracket

Home Runs - Major Rule = 8 per Team per Game, Outs

**NOTE** SSUSA Official Rulebook §9.5 (Retrieving Home Run Balls) will be strictly enforced.

Run Rules - 5 runs per ½ inning at bat (except open inning)

Time Limits - RR = 65 + open inn. • Bracket = 70 + open inn. • Championship game(s) = 7 innings full

Tie Breakers - Head to head (in full RR only), least runs allowed, run differential, coin toss

**Schedule Subject to Change at Discretion of Tournament and Field Directors**



# Jim Sherman Memorial Northwest Championships 2014

## Portland, Oregon June 28 - 29, 2014

Rev. 06/21/2014

### Men's 40+ Masters Major Division • 5 Teams

#### Championship Bracket

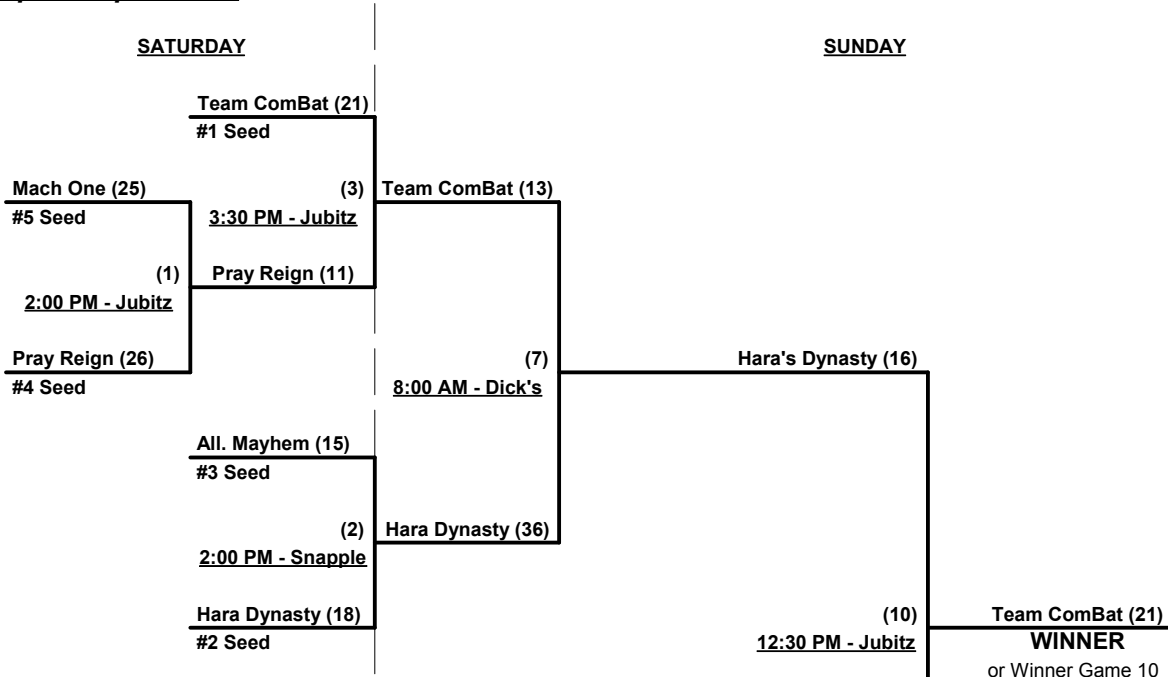

#### Elimination Bracket

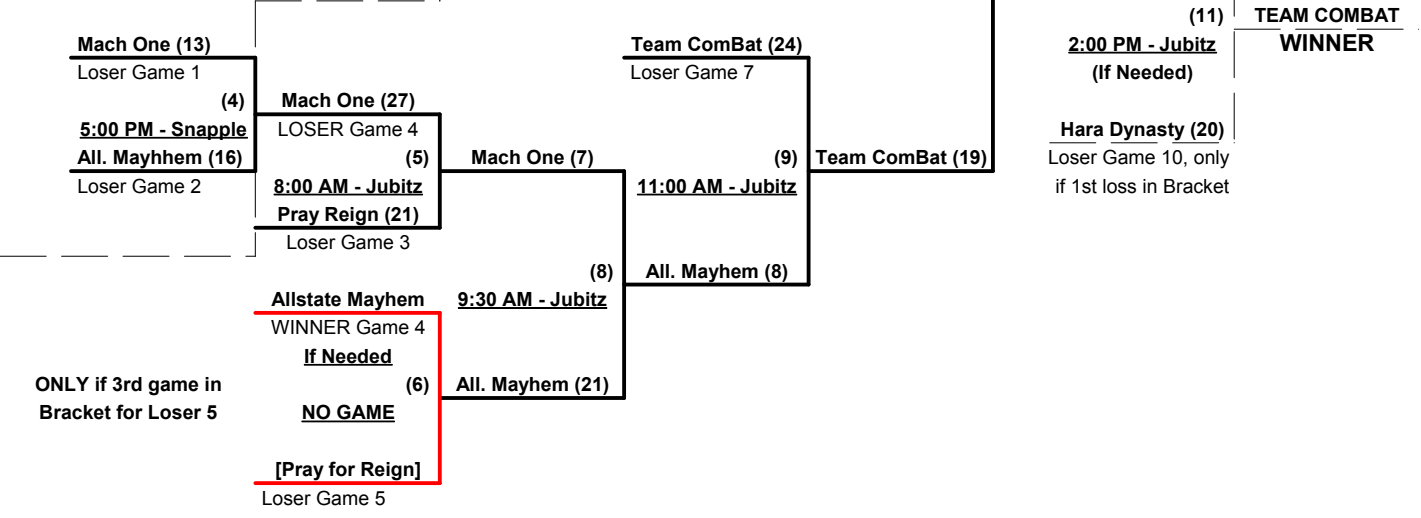



# Jim Sherman Memorial Northwest Championships 2014

## Portland, Oregon

### June 27 - 29, 2014

Rev. 06/21/2014

### Men's 50/55+ Platinum Division • 6 Teams

<u>Win</u>	<u>Loss</u>		<u>Win</u>	<u>Loss</u>	
1	1	1 Pacific NW Legends (WA)	1	1	4 Doerflinger Softball (WA)
1½	½	2 CornerStone (OR)	1½	½	5 So. Oregon Flatliners
0	2	3 Credicor Financial (BC)	1	1	6 Goodman Racing 55 (WA)

### Friday • June 27, 2014 • William V. Owens Softball Complex at Delta Park

Time	#	Runs	Team Name	Field	#	Runs	Team Name
12:00 PM	2	16	CornerStone (OR)	B	3	10	Credicor Financial (BC)
1:30 PM	6	69	Goodman Racing 55 (WA)	S	5	10	So. Oregon Flatliners
1:30 PM	4	20	Doerflinger Softball (WA)	B	1	30	§ Pacific NW Legends (WA)
3:00 PM	3	21	Credicor Financial (BC)	J	4	22	Doerflinger Softball (WA)
3:00 PM	5	20	So. Oregon Flatliners	S	2	20	CornerStone (OR)
3:00 PM	1	19	§ Pacific NW Legends (WA)	B	6	21	Goodman Racing 55 (WA)

§ Team #1 GIVES 5-Run equalizer in ALL games • Games played under Major+ Rules

Seeding for 50/55-Platinum Three-Game-Guarantee bracket commencing Saturday morning • See bracket

**FIELD CODES: B=Budweiser • DS=Dick's Sports • DM=DeMarini • J=Jubitz • M=Marathon • S=Snapple**

**Format:** Two (2) game Round Robin to seed 50/55-Platinum Three-game-guarantee Championship bracket  
**NOTE:** ONE Award set in all brackets • If Team #6 wins, runner-up receives 2015 T.O.C. bid in 50-Major  
 Team #1 plays "Exhibition" • Seeded last (#6) and cannot advance in bracket  
 All games involving Team #1 ("Exhibition") played under Major+ Rules  
 Home Runs - HR Rule of LOWER rated team in game • EXCEPT games involving Team #1  
 Major+ = 9 per team per game, Outs Major = 6 per team per game, Outs  
**NOTE:** SSUSA Official Rulebook §9.5 (Retrieving Home Run Balls) will be strictly enforced.  
 Time Limits - RR = 65 + open inn. • Bracket = 70 + open inn. • Championship game(s) = 7 innings full  
 Run Rules - 5 runs per ½ inning at bat (except open inning)  
 Tie Breakers - Head to head (in full RR only), least runs allowed, run differential, coin toss  
**MAJOR PLUS RULES • For games involving Team #1 ("Exhibition")**  
 Home Runs - Major+ Rule = 9 per team per game, Outs  
 Run Rules - 7 runs per ½ inning at bat (except open inning)  
 Mercy Rule - Fifteen (15) runs after 5 innings

**Schedule Subject to Change at Discretion of Tournament and Field Directors**



# Jim Sherman Memorial Northwest Championships 2014

## Portland, Oregon June 27 - 29, 2014

Rev. 06/21/2014

### Men's 50/55+ Platinum Division - 6 Teams

#### Championship Bracket

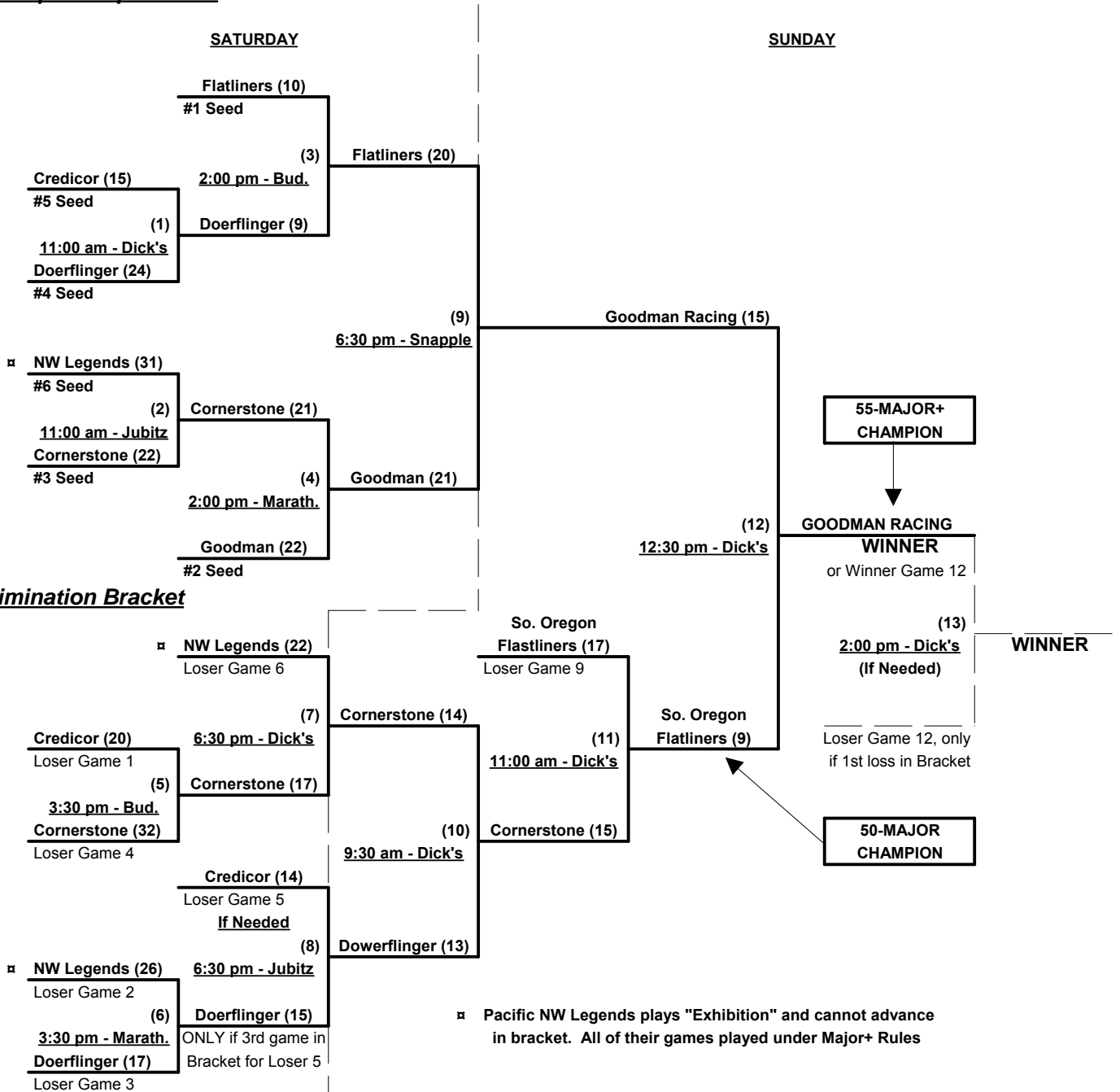



# Jim Sherman Memorial Northwest Championships 2014

## Portland, Oregon

### June 27 - 29, 2014

Rev. 06/27/2014

### Men's 50+ AAA Division • 6 Teams

Win	Loss		
1	1	1	A-1 Light Trucking (WA)
0	2	2	Alaska Kings 50's (AK)
2	0	3	Dead Sailors (WA)
2	0	4	McU Sports (ID)

Win	Loss		
1	1	5	Michael's Toyota (WA)
•	•	6	Slayers (OR) • NO SHOW
0	2	7	Tax Minimizers/B&B (OR)

### Friday • June 27, 2014 • William V. Owens Softball Complex at Delta Park

Time	#	Runs	Team Name	Field	#	Runs	Team Name
9:00 AM	5	24	Michael's Toyota (WA)	J	2	15	Alaska Kings 50's (AK)
9:00 AM	3	14	Dead Sailors (WA)	B	7	3	Tax Minimizers/B&B (OR)
10:30 AM	2	13	Alaska Kings 50's (AK)	J	3	25	Dead Sailors (WA)
10:30 AM	7	21	Tax Minimizers/B&B (OR)	B	1	23	A-1 Light Trucking (WA)
12:00 PM	4	17	McU Sports (ID)	S	5	13	Michael's Toyota (WA)
1:30 PM	1	11	A-1 Light Trucking (WA)	DM	4	21	McU Sports (ID)

Seeding for 50-AAA Three-Game-Guarantee bracket commencing Saturday morning • See bracket

**FIELD CODES: B=Budweiser • DS=Dick's Sports • DM=DeMarini • J=Jubitz • M=Marathon • S=Snapple**

**Format:** Two (2) game Round Robin to seed 50-AAA Three-game-guarantee Championship bracket

Home Runs - AAA Rule = 3 per Team per Game, Outs

**NOTE** SSUSA Official Rulebook §9.5 (Retrieving Home Run Balls) will be strictly enforced.

Run Rules - 5 runs per ½ inning at bat (except open inning)

Time Limits - RR = 65 + open inn. • Bracket = 70 + open inn. • Championship game(s) = 7 innings full

Tie Breakers - Head to head (in full RR only), least runs allowed, run differential, coin toss

**Schedule Subject to Change at Discretion of Tournament and Field Directors**



# Jim Sherman Memorial Northwest Championships 2014

## Portland, Oregon June 27 - 29, 2014

Rev. 06/27/2014

### Men's 50+ AAA Division - 6 Teams

#### Championship Bracket

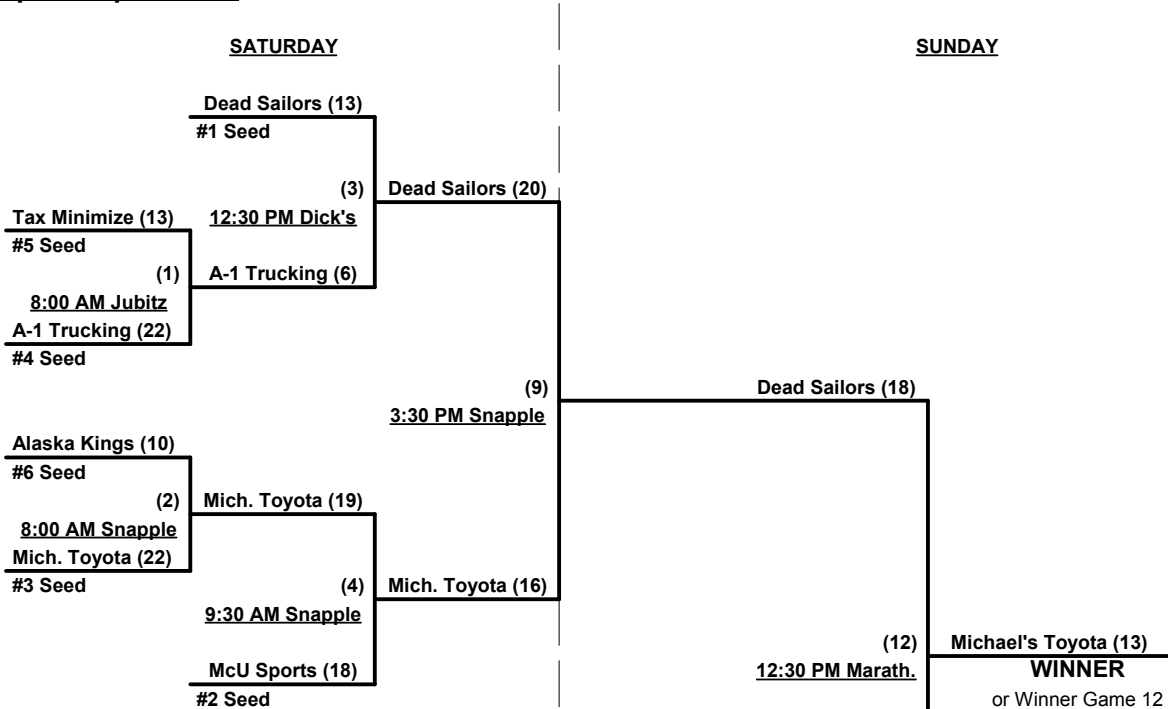

#### Elimination Bracket

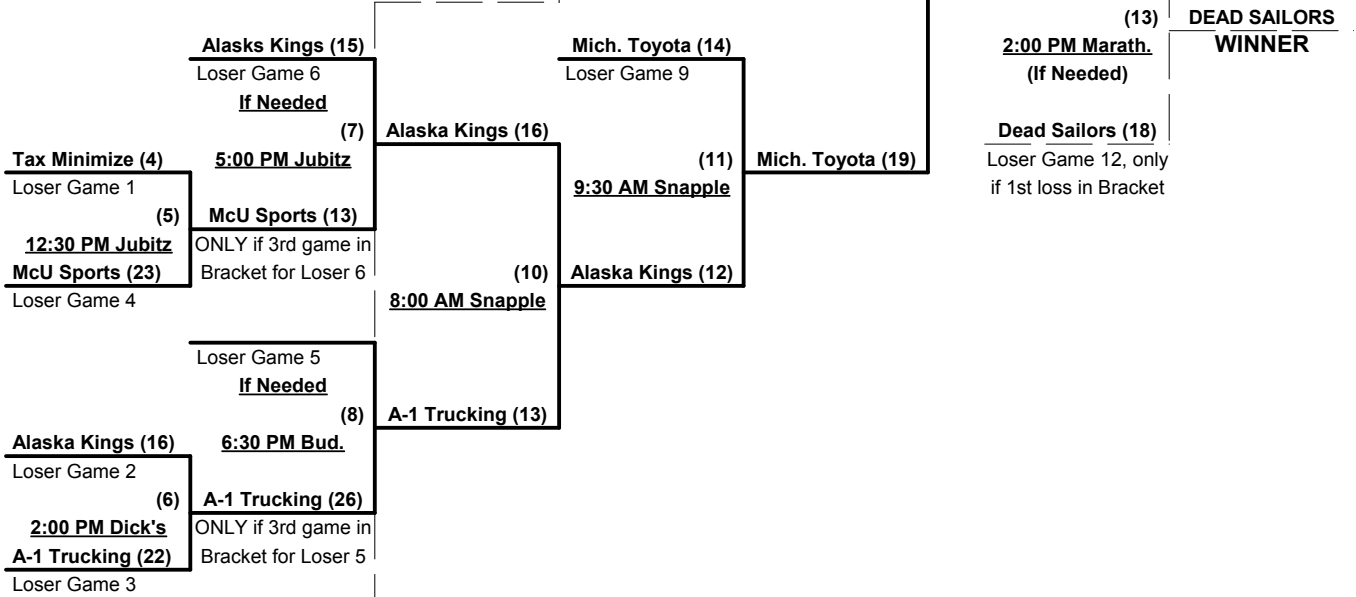



# Jim Sherman Memorial Northwest Championships 2014

## Portland, Oregon

### June 27 - 29, 2014

Rev. 06/21/2014

### Men's 55/60+ Gold Division • 6 Teams

<u>Win</u>	<u>Loss</u>		<u>Win</u>	<u>Loss</u>	
1	1	1	0	2	4
2	0	2	2	0	5
1	1	3	0	2	6

1 Four Seasons/W&W (OR)  
 2 Wolfpack (WA)  
 3 Timberworks Const. (CA)

4 Vancouver USA 50 (WA)  
 5 Wilson & Sons Auto (ID)  
 6 X-Men (BC)

### Friday • June 27, 2014 • William V. Owens Softball Complex at Delta Park

Time	#	Runs	Team Name	Field	#	Runs	Team Name
9:00 AM	6	8	X-Men (BC)	DS	1	22	§ Four Seasons/W&W (OR)
9:00 AM	4	13	Vancouver USA 50 (WA)	M	2	18	§ Wolfpack (WA)
10:30 AM	2	22	§ Wolfpack (WA)	DS	6	9	X-Men (BC)
10:30 AM	5	19	Wilson & Sons Auto (ID)	M	4	13	Vancouver USA 50 (WA)
12:00 PM	1	15	Four Seasons/W&W (OR)	DS	3	18	Timberworks Const. (CA)
1:30 PM	3	22	§ Timberworks Const. (CA)	DS	5	23	Wilson & Sons Auto (ID)

### Saturday • June 28, 2014 • William V. Owens Softball Complex at Delta Park

Time	#	Runs	Team Name	Field	#	Runs	Team Name
9:30 AM	3	25	§ Timberworks Const. (CA)	J	6	22	X-Men (BC)
11:00 AM	1	12	§ Four Seasons/W&W (OR)	S	4	19	Vancouver USA 50 (WA)
11:00 AM	5	7	Wilson & Sons Auto (ID)	B	2	17	§ Wolfpack (WA)

§ Teams #1-3 GIVE 5-Run OR 11-Defensive-player equalizer in games vs. Teams #4-6

Seeding for Double Elimination Championship brackets commencing Saturday afternoon • See brackets

**FIELD CODES: B=Budweiser • DS=Dick's Sports • DM=DeMarini • J=Jubitz • M=Marathon • S=Snapple**

**Format:** Mixed 3-game Round Robin to seed Championship Brackets

Teams #1-3 play Double Elimination bracket for 55/60-Platinum Championship

Teams #4-6 play Double Elimination bracket for 50/55-Silver Championship

**NOTE:** ONE Award set in all brackets • If singleton team wins, runner-up receives 2015 T.O.C. bid

Home Runs - HR Rule of LOWER rated team in game      Major = 6 per team per game, Outs

AAA = 3 per team per game, Outs      AA = 1 per team per game, Outs

**NOTE:** SSUSA Official Rulebook §9.5 (Retrieving Home Run Balls) will be strictly enforced.

Time Limits - RR = 65 + open inn. • Bracket = 70 + open inn. • Championship game(s) = 7 innings full

Run Rules - 5 runs per ½ inning at bat (except open inning)

Tie Breakers - Head to head (in full RR only), least runs allowed, run differential, coin toss

**Schedule Subject to Change at Discretion of Tournament and Field Directors**



# Jim Sherman Memorial Northwest Championships 2014

## Portland, Oregon

### June 27 - 29, 2014

Rev. 06/21/2014

### Men's 55/60+ Platinum Division - 3 Teams

#### Championship Bracket

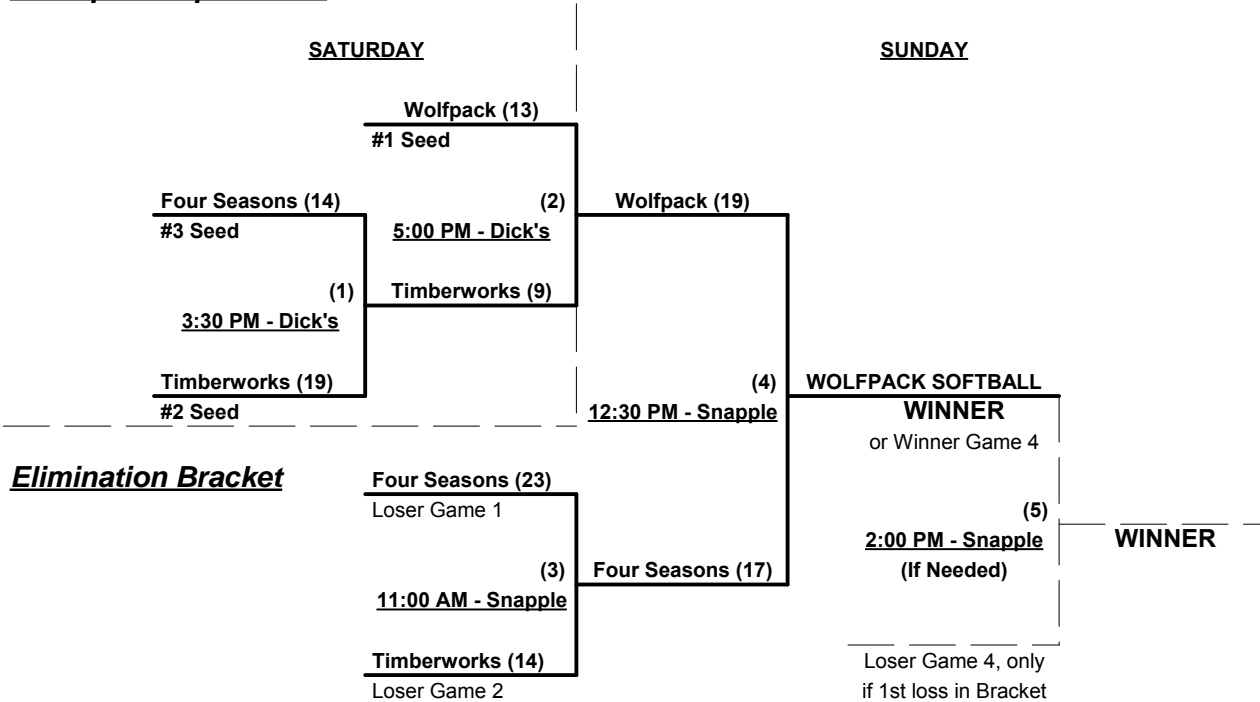

#### Elimination Bracket

### Men's 50/55+ Silver Division - 3 Teams

#### Championship Bracket



#### Elimination Bracket





# Jim Sherman Memorial Northwest Championships 2014

## Portland, Oregon

### June 27 - 29, 2014

Rev. 06/23/2014

### Men's 55/60+ AA Division • 5 Teams

<u>Win</u>	<u>Loss</u>	<u>55-AA</u>	<u>Win</u>	<u>Loss</u>	<u>60-AA</u>
2	1	1 Cascade Thunder (OR)	3	0	3 Northwest Silver 60's (WA)
1	2	2 Vancouver USA 55 (WA)	2	1 (1)	4 Stagecoach Saloon (OR)
			0	3	5 Vancouver USA 60 (WA)

### Friday • June 27, 2014 • William V. Owens Softball Complex at Delta Park

Time	#	Runs	Team Name	Field	#	Runs	Team Name
9:00 AM	2	16	§ Vancouver USA 55 (WA)	DM	3	11	Northwest Silver 60's (WA)
10:30 AM	1	12	Cascade Thunder (OR)	DM	2	14	Vancouver USA 55 (WA)
12:00 PM	3	18	Northwest Silver 60's (WA)	DM	5	17	Vancouver USA 60 (WA)
12:00 PM	4	19	Stagecoach Saloon (OR)	J	1	18	§ Cascade Thunder (OR)
1:30 PM	5	14	Vancouver USA 60 (WA)	J	4	15	Stagecoach Saloon (OR)

### Saturday • June 28, 2014 • William V. Owens Softball Complex at Delta Park

Time	#	Runs	Team Name	Field	#	Runs	Team Name
8:00 AM	3	15	Northwest Silver 60's (WA)	DS	4	14	Stagecoach Saloon (OR)
9:30 AM	1	20	§ Cascade Thunder (OR)	DM	5	11	Vancouver USA 60 (WA)
9:30 AM	4	14	¶ Stagecoach Saloon (OR)	DS	2	20	§ Vancouver USA 55 (WA)

§ Teams #1-2 GIVE 5-Run OR 11-Defensive-player equalizer in games vs. Teams #3-5  
 ¶ Exhibition for Team #4 (ONLY) • Does NOT count in Round Robin standings

**Seeding for Double Elimination Championship brackets commencing Saturday afternoon • See brackets**

**FIELD CODES: B=Budweiser • DS=Dick's Sports • DM=DeMarini • J=Jubitz • M=Marathon • S=Snapple**

**Format:** Mixed 3-game Round Robin to seed Championship Brackets  
 Teams #1-2 play Best 2 of 3 Series for 55-AA Championship  
 Teams #3-5 play Double Elimination bracket for 60-AA Championship  
 Home Runs - AA Rule = 1 per Team per Game, Outs  
**NOTE** SSUSA Official Rulebook §9.5 (Retrieving Home Run Balls) will be strictly enforced.  
 Run Rules - 5 runs per ½ inning at bat (except open inning)  
 Time Limits - RR = 65 + open inn. • Bracket = 70 + open inn. • Championship game(s) = 7 innings full  
 Tie Breakers - Head to head (in full RR only), least runs allowed, run differential, coin toss

**Schedule Subject to Change at Discretion of Tournament and Field Directors**



**Jim Sherman Memorial Northwest Championships 2014**  
**Portland, Oregon**  
**June 27 - 29, 2014**

Rev. 06/21/2014

**Men's 55+ AA Division - 2 Teams**

**Championship Bracket**

**SATURDAY**

**SUNDAY**

Cas. Thunder (13)

(1) Vancouver 55 (11)

11:00 AM - DeMarini

Vancouver 55 (14)

(2) Cascade Thunder (17)

8:00 AM - DeMarini

**WINNER**

or Winner Game 2

(3)

9:30 AM - DeMarini

(If Needed)

Vancouver 55 (13)

Loser Game 2, only

if 1st loss in Bracket

**CASCADE  
THUNDER  
WINNER**

Cas. Thunder (17)

Loser Game 1

**Elimination Game**

**Men's 60+ AA Division - 3 Teams**

**Championship Bracket**

**SATURDAY**

**SUNDAY**

NW Silver (18)

#1 Seed

Vancouver 60 (15)

#3 Seed

(2) NW Silver (14)

2:00 PM - DeMarini

(1)

Vancouver 60 (16)

12:30 PM - DeMarini

Stagecoach (14)

#2 Seed

(4) Stagecoach Saloon (21)

12:30 PM - DeMarini

**WINNER**

or Winner Game 4

(5)

2:00 PM - DeMarini

(If Needed)

NW Silver (16)

Loser Game 4, only

if 1st loss in Bracket

**STAGECOACH  
SALOON  
WINNER**

Stagecoach (21)

Loser Game 1

(3)

11:00 AM - DeMarini

Vancouver 60 (20)

Loser Game 2

**Elimination Bracket**



# Jim Sherman Memorial Northwest Championships 2014

## Portland, Oregon

### June 27 - 29, 2014

Rev. 06/21/2014

### Men's 60+ Gold Division • 4 Teams

<u>Win</u>	<u>Loss</u>			<u>60-Major</u>			<u>Win</u>	<u>Loss</u>			<u>60-AAA</u>
1	2	1		Enviro-Vac Marauders (BC)			1	2	3		Aro Glass Clubbers (WA)
2	1	2		MBA Elite 60 (CA)			2	1	4		Last Call (NV)

### Friday • June 27, 2014 • William V. Owens Softball Complex at Delta Park

Time	#	Runs	Team Name	Field	#	Runs	Team Name
12:00 PM	1	6	Enviro-Vac Marauders (BC)	M	2	14	MBA Elite 60 (CA)
1:30 PM	4	22	Last Call (NV)	M	3	23	Aro Glass Clubbers (WA)
3:00 PM	2	14	§ MBA Elite 60 (CA)	DS	4	17	Last Call (NV)
3:00 PM	3	14	Aro Glass Clubbers (WA)	M	1	16	§ Enviro-Vac Marauders (BC)

### Saturday • June 28, 2014 • William V. Owens Softball Complex at Delta Park

Time	#	Runs	Team Name	Field	#	Runs	Team Name
12:30 PM	1	5	§ Enviro-Vac Marauders (BC)	B	4	19	Last Call (NV)
12:30 PM	3	16	Aro Glass Clubbers (WA)	M	2	17	§ MBA Elite 60 (CA)

§ Teams #1-2 GIVE 5-Run OR 11-Defensive-player equalizer in ALL games vs. Teams #3-4

Seeding for 60-Gold Double Elimination bracket commencing Saturday afternoon • See bracket

**FIELD CODES: B=Budweiser • DS=Dick's Sports • DM=DeMarini • J=Jubitz • M=Marathon • S=Snapple**

**Format:** Full (3-game) Round Robin to seed 60-Gold Double Elimination Championship bracket

**NOTE:** ONE Award set in all brackets • Top finishing 60-Major AND 60-AAA each receive 2015 T.O.C. bid

Home Runs - HR Rule of LOWER rated team in game  
 Major = 6 per team per game, Outs                      AAA = 3 per team per game, Outs

**NOTE:** SSUSA Official Rulebook §9.5 (Retrieving Home Run Balls) will be strictly enforced.

Time Limits - RR = 65 + open inn. • Bracket = 70 + open inn. • Championship game(s) = 7 innings full

Run Rules - 5 runs per ½ inning at bat (except open inning)

Tie Breakers - Head to head (in full RR only), least runs allowed, run differential, coin toss

**Schedule Subject to Change at Discretion of Tournament and Field Directors**



**Jim Sherman Memorial Northwest Championships 2014**  
 Portland, Oregon  
 June 27 - 29, 2014

Rev. 06/21/2014

**Men's 60+ Gold Division • 4 Teams**

**Championship Bracket**

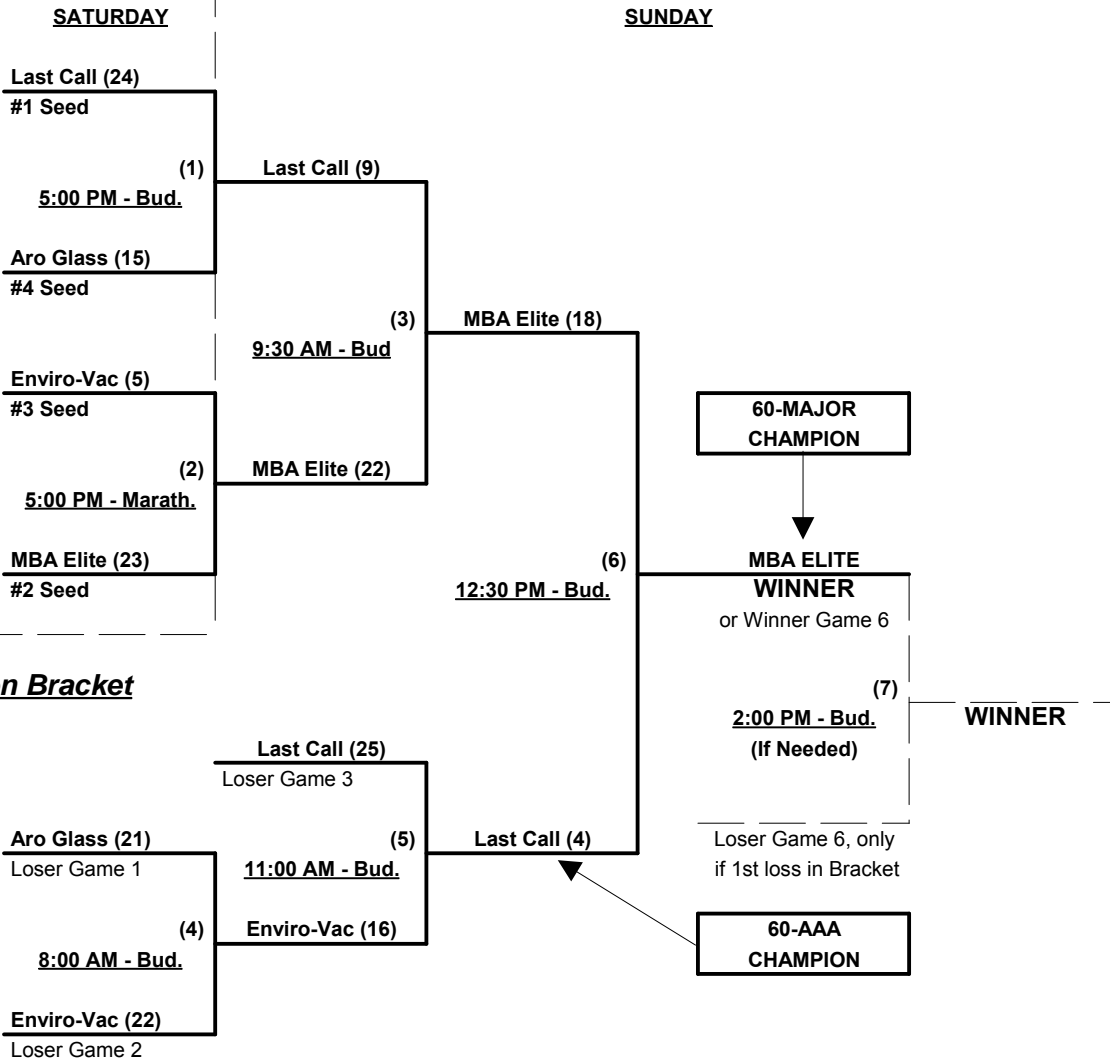

**Elimination Bracket**

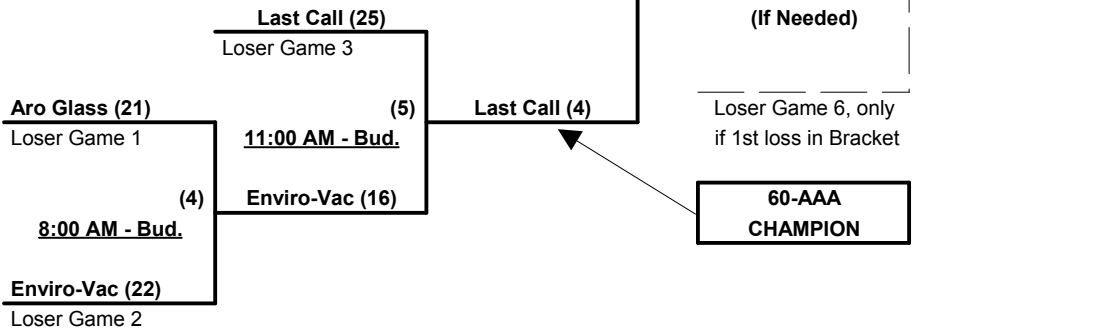



# Jim Sherman Memorial Northwest Championships 2014 Portland, Oregon June 24 - 26, 2014

Rev. 06/20/2014

## Men's 65/70+ Division • 10 Teams

<u>Win</u>	<u>Loss</u>		<u>Win</u>	<u>Loss</u>	
1	2	1 W.E. Ruth Realty 65 (WA)	2	1	6 Suburban Auto Group (WA)
3	0	2 Enviro-Vac Marauder 65 (BC)	0	3	7 Bonaventure/CE John (WA)
1	2	3 Masters Marauders (BC)	2	1	8 Northwest Silver 65 (WA)
2	1	4 Last Call 65 (NV)	1	2	9 Sims 65 (WA)
2	1	5 Sacramento Islanders (CA)	1	2	10 Sunlight Supply (WA)

### Tuesday • June 24, 2014 • William V. Owens Softball Complex at Delta Park

Time	#	Runs	Team Name	Field	#	Runs	Team Name
10:00 AM	6	<u>15</u>	Suburban Auto Group (WA)	DS	10	<u>14</u> §	Sunlight Supply (WA)
10:00 AM	3	<u>15</u> §	Masters Marauders (BC)	J	1	<u>13</u>	W.E. Ruth Realty 65 (WA)
10:00 AM	7	<u>10</u>	Bonaventure/CE John (WA)	B	9	<u>13</u> §	Sims 65 (WA)
10:00 AM	4	<u>21</u>	Last Call 65 (NV)	M	8	<u>19</u> §	Northwest Silver 65 (WA)
11:30 AM	10	<u>23</u> §	Sunlight Supply (WA)	DS	7	<u>8</u>	Bonaventure/CE John (WA)
11:30 AM	2	<u>21</u>	Enviro-Vac Marauder 65 (BC)	J	6	<u>6</u> §	Suburban Auto Group (WA)
11:30 AM	9	<u>16</u> §	Sims 65 (WA)	B	4	<u>21</u>	Last Call 65 (NV)
11:30 AM	8	<u>20</u> §	Northwest Silver 65 (WA)	M	5	<u>9</u>	Sacramento Islanders (CA)
1:00 PM	5	<u>21</u> §	Sacramento Islanders (CA)	DS	3	<u>6</u>	Masters Marauders (BC)
1:00 PM	1	<u>12</u>	W.E. Ruth Realty 65 (WA)	J	2	<u>19</u> §	Enviro-Vac Marauder 65 (BC)

### Wednesday • June 25, 2014 • William V. Owens Softball Complex at Delta Park

Time	#	Runs	Team Name	Field	#	Runs	Team Name
8:30 AM	7	<u>19</u>	Bonaventure/CE John (WA)	DS	8	<u>26</u> §	Northwest Silver 65 (WA)
8:30 AM	9	<u>7</u> §	Sims 65 (WA)	J	6	<u>21</u>	Suburban Auto Group (WA)
8:30 AM	1	<u>20</u>	W.E. Ruth Realty 65 (WA)	B	4	<u>18</u> ¶	Last Call 65 (NV)
8:30 AM	5	<u>16</u>	Sacramento Islanders (CA)	M	10	<u>15</u> §	Sunlight Supply (WA)
10:00 AM	2	<u>16</u>	Enviro-Vac Marauder 65 (BC)	M	3	<u>7</u>	Masters Marauders (BC)

§ Team noted RECEIVES 5-Run or 11-Defensive-player equalizer in stated game

¶ Team #4 RECEIVES 5-Run AND 11-Defensive-player equalizer in game vs. Team #1

**FIELD CODES: B=Budweiser • DS=Dick's Sports • DM=DeMarini • J=Jubitz • M=Marathon • S=Snapple**

**Format:** Mixed Round Robin to seed Championship Elimination Brackets beginning WEDNESDAY afternoon

**NOTE:** ONE Award set in all brackets • If singleton team wins, runner-up receives 2015 T.O.C. Bid

Teams #1-3 play Double Elimination bracket for 65-Platinum Championship (Internal seeding)

Teams #4-7 play Double Elimination bracket for 65-70-Gold Championship

Teams #8-10 play Double Elimination bracket for 65-AA Championship

Home Runs - HR Rule of LOWER rated team in game

Major = 6 per team per game, Outs

AAA = 3 per team per game, Outs

AA = 1 per team per game, Outs

**NOTE:** SSUSA Official Rulebook §9.5 (Retrieving Home Run Balls) will be strictly enforced.

Time Limits - RR = 65 + open inn. • Bracket = 70 + open inn. • Championship game(s) = 7 innings full

Tie Breakers - Head to head (in full RR only), least runs allowed, run differential, coin toss

**Schedule Subject to Change at Discretion of Tournament and Field Directors**



# Jim Sherman Memorial Northwest Championships 2014

## Portland, Oregon June 24 - 26, 2014

Rev. 06/20/2014

### Men's 65+ Platinum Division - 3 Teams

#### Championship Bracket

WEDNESDAY

THURSDAY

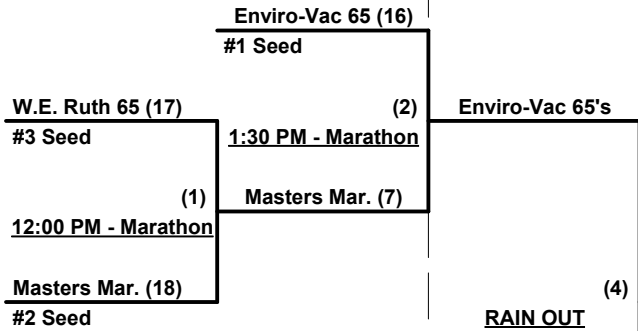

§ W.E. Ruth GIVES 5-Run OR 11-Defensive-player equalizer in ALL bracket games

**RAIN SHORTENED ORDER OF FINISH**

1. Enviro-Vac Marauders 65
2. Masters Marauders
3. W.E. Ruth Realty 65

#### Elimination Bracket

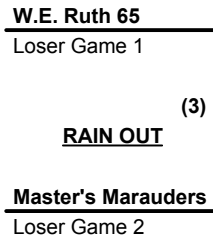

**WINNER**  
or Winner Game 4

(5)  
RAIN OUT  
(If Needed)

**WINNER**

Loser Game 4, only  
if 1st loss in Bracket

### Men's 65+ AA Division - 3 Teams

#### Championship Bracket

WEDNESDAY

THURSDAY

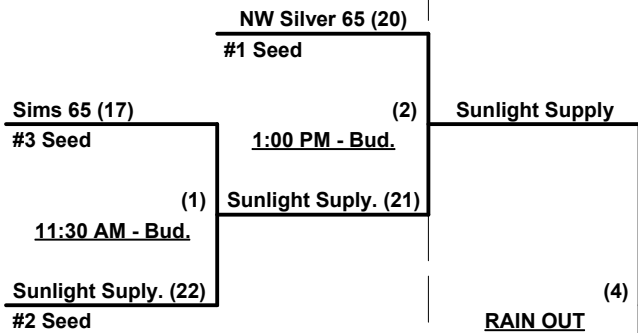

**RAIN SHORTENED ORDER OF FINISH**

1. Sunlight Supply
2. Northwest Silver 65
3. Sims 65

#### Elimination Bracket

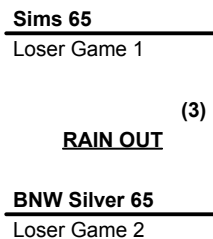

**WINNER**  
or Winner Game 4

(5)  
RAIN OUT  
(If Needed)

**WINNER**

Loser Game 4, only  
if 1st loss in Bracket



**Jim Sherman Memorial Northwest Championships 2014**  
 Portland, Oregon  
 June 24 - 26, 2014

Rev. 06/20/2014

**Men's 65/70+ Gold Division - 4 Teams**

**Championship Bracket**

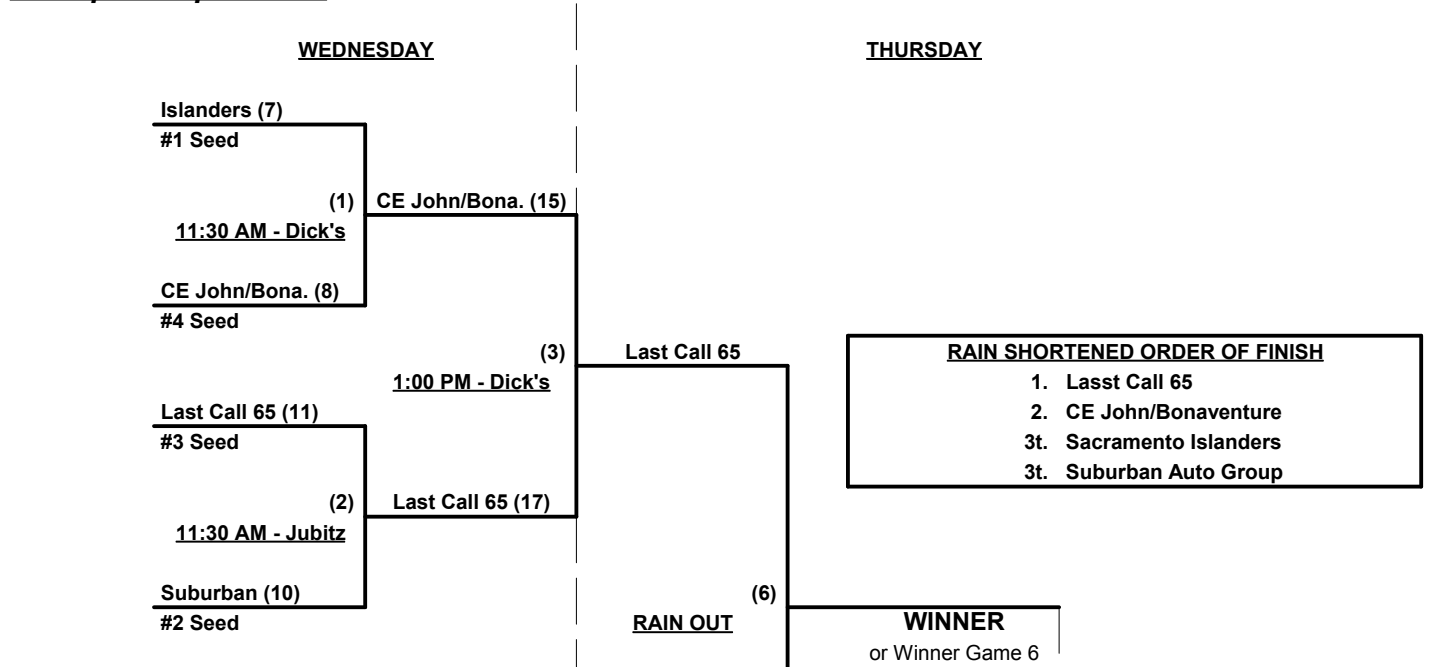

**Elimination Bracket**

